

# Multifit LegLifter Mk3L

## User Manual



### Information index

	Page
Components	1
Uses and limitations	2
Safety features and precautions	2
Pre-installation advice	3
Interchanging leg-rests to suit patient needs	4
Domestic bed installation	5
How to use the Multifit LegLifter	6
Maintenance and Trouble-shooting Guide	7
Specifications and Warranty	8
Compliance Statement and contact information	8

### Multifit LegLifter Mk3L Components

Diagram shows LegLifter unit assembly for LEFT bedside. Right bedside assembly is opposed left to right.

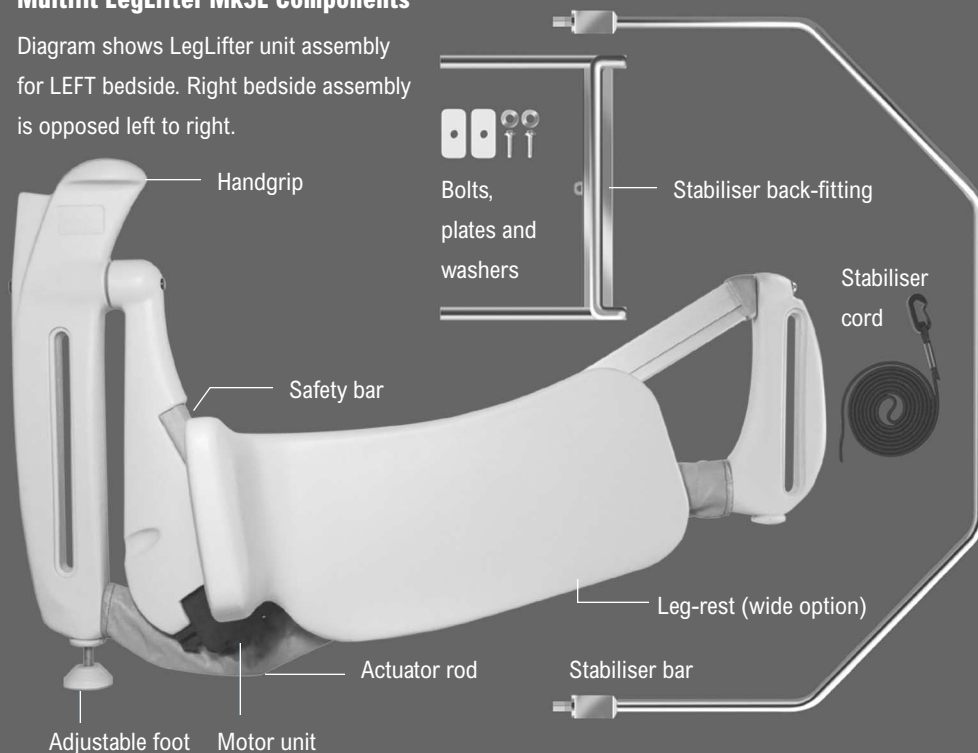

Handset



Control box and power cable



**Thank you for purchasing this Multifit LegLifter.** This is a quality, long-lasting appliance designed to give you many years of trouble-free service. For your own safety, ensure that you and others involved in the use of this appliance read these instructions carefully. If you are uncertain about any instruction, or if you need further information, please contact your distributor.

### General description and intended use

The Multifit LegLifter is a motor-driven appliance designed to provide independence for disabled people who are unable to lift their legs from a bedside sitting position to the surface of the bed. With simple push-button commands, the LegLifter gently and smoothly carries the legs from the bedside to the prone position on the bed surface.

The conveniently located handgrip can be used to aid transfer on and off the bed as well as to assist with balance while reclining. Depending on the level of disability, the process can be performed with minimal or no assistance from another person.

With the correct attachments, the LegLifter may be fitted to standard innerspring beds, slat beds, divan beds and some profiling beds. See Specifications on page 8 for the range of adjustment. Consult your distributor regarding correct configuration for your specific bed type.

### Safety features

- 1 Safety bar on the lift-arm turns the motor off in event of obstruction in the downward motion of the leg-rest.
- 2 Telescopic support prevents leg-rest lowering under power in event of obstruction.
- 3 Smooth profile and rounded edges reduce injury risk.
- 4 Green light on the handset turns on to warn that the leg-rest is in motion or in a raised position. The light turns off when the leg-rest is fully raised. It also turns off when the leg-rest is returned completely to the bedside, where it will not present an obstacle to getting out of bed.
- 5 A key-lock for the handset, which immobilises the handset when the key is removed, is available on request.
- 6 Low 28V power to the LegLifter appliance.

### Limitations on use

- 1 The LegLifter must not be used to lift anything other than the legs of the person for which it is intended, and only when they are seated correctly on the edge of the bed.
- 2 The LegLifter should not be used to lift the complete weight of a person.
- 3 The LegLifter should not be used or operated by a child under the age of 12 years.
- 4 The LegLifter is not intended to lift the legs out of bed.
- 5 The LegLifter should not be operated by people without the ability or understanding to operate the handset control.

### Safety precautions

- 1 Properly dispose of all plastic wrap from your Multifit LegLifter packaging, away from the reach of small children.
- 2 Ensure that control unit voltage and cables are intended for your power supply.
- 3 During installation, ensure that the LegLifter's stabiliser back-fitting is securely fastened on the opposite side of the bed base and that the LegLifter fits firmly and securely against the bedside (see page 5).
- 4 After installation, ensure that the control box and power cords are tucked away from traffic areas to avoid trip hazards.
- 5 Before operation, ensure that all power connections are firmly inserted.
- 6 Keep small children away from the LegLifter while it is in use, and keep the operator handset out of their reach.
- 7 Ensure the user is physically and mentally able to use the LegLifter safely.
- 8 Allow plenty of clear space beside the bed to enable easy access to and from the bedside (which may include wheelchair space). Ensure at least 600mm clear space for the lift-arm to operate without obstruction, and ensure that no objects, including blankets, can interfere with free movement of the lift-arm and leg-rest.
- 9 To avoid the unlikely event of overheating of the actuator under heavy load, recommended active/inactive operation ratio is (eg) 2 minutes operation (intermittent) per 20 minutes of non-operation.
- 10 Do not use any other power control box other than the TiMotion TC2B or TC1 model supplied with the LegLifter unit.

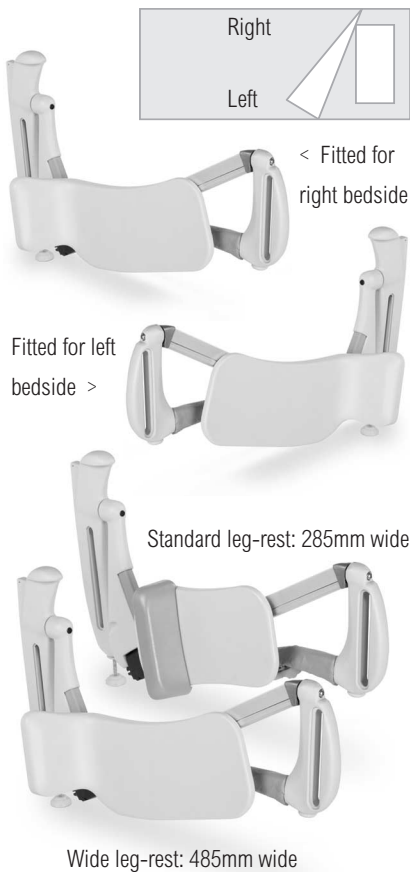

**Is your Multifit LegLifter configured for correct bedside access?**

◀ To suit individual preferences for bedside access, the Multifit LegLifter is configured before delivery to fit on either the LEFT or RIGHT side of the bed (viewed from lying on the bed), with the leg-rest facing out. Confirm that your LegLifter is correctly configured for your preferred bedside access.

**Is your Multifit LegLifter suitable for your bed design?**

The standard Multifit LegLifter MK3 is supplied with a stabiliser bar and bracket designed for installation to a typical innerspring domestic bed. Multifit can also supply stability bars and brackets designed to cope with the mattress-retaining rim typical of many box-base and slat-bed designs.

Multifit LegLifter model MK3-L is designed for fitting to adjustable profiling beds. Manufacturing specifications vary and your profiling bed supplier should be consulted to arrange installation. See page 6 of this manual for instructions.

**Is the supplied leg-rest the most suitable size for your patient?**

◀ Multifit LegLifter Mk3 offers options of a standard leg-rest, or a wider leg-rest for patients affected by conditions of heavy or swollen legs.

**Have you received all Multifit LegLifter components?**

Multifit LegLifter is supplied in flatpack for shipping and storage. Check the pack components with the appropriate diagram on the front cover of this manual to ensure all items have been included.





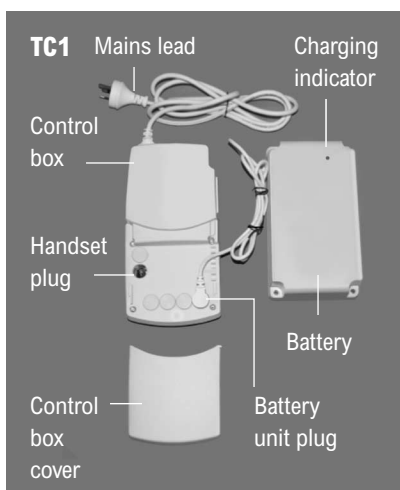
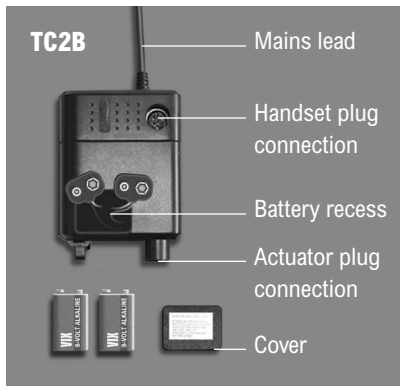

**Do you require an optional battery back-up in event of mains-power failure?**

◀ **TC2B Control Box (standard)** offers battery backup (2 x 9V alkaline batteries, not included in kit) for emergency LOWERING ONLY of the leg-rest. The TC2 battery back-up provides ONE lowering operation only – new batteries are required for the next operation. Standard 9V alkaline batteries are usually widely available and may be installed by your distributor on request. To insert batteries: (1) Disconnect control box from mains supply. (2) Remove battery cover and connect batteries. (3) Insert batteries into recess and replace cover.

◀ **TC1 Control Box (optional)** offers a separate rechargeable battery pack, which automatically recharges every time the appliance is used on mains-power supply. In event of mains-power outage, the battery provides up to six lifting and lowering operations from a fully recharged battery unit, depending on the weight of the patient's legs.



**Classifications reference**

-  Double insulation
-  Fail-safe safety isolation transformer
-  CE marking 93/42/EEC
-  Type B applied part
-  For indoor use only
-  Dispose of product correctly

## 4 Interchanging standard and large leg-rests

The leg-rests are fixed to the lift arm by four bolts through the white block on the lift arm into four nutserts on the round plate underneath the leg-rest. Both leg-rest models have identical nutsert layouts to facilitate interchange.

Standard leg-rest: underside

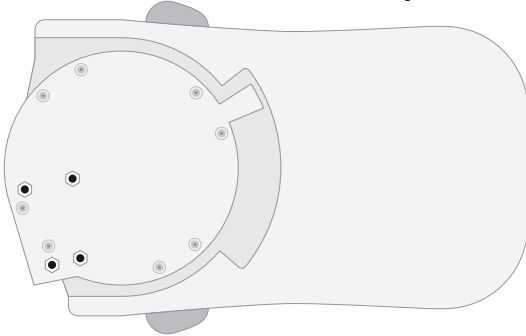

Wide leg-rest: underside

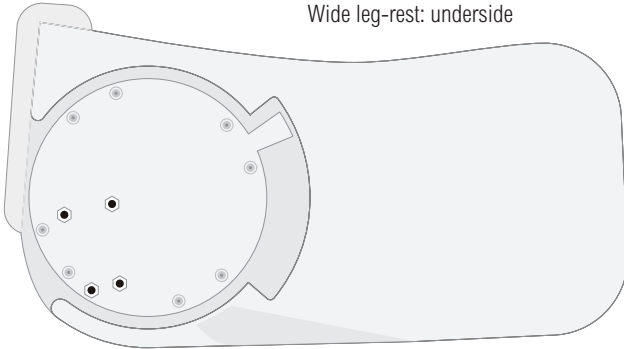

- 1 Stand the LegLifter so that both sides of the appliance are easily accessible.
- 2 Use an Allen key to remove the four bolts located on the white block behind the leg-rest. Retain the washers with the bolts.

Installed leg-rest:

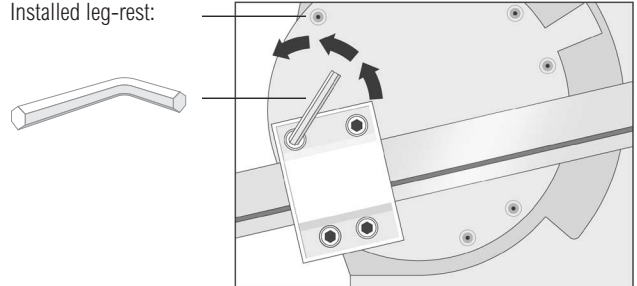

- 3 Remove the leg-rest from the appliance. Position the replacement leg-rest so that its four nutserts locate into the four recesses in the back of the white block on the actuator.

Replacement leg-rest:

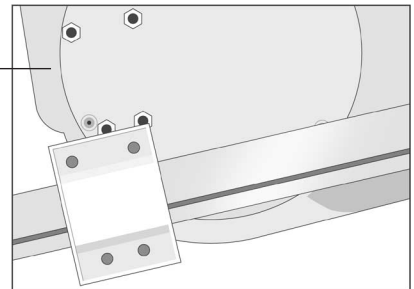

- 4 With washers intact, carefully screw the bolts back into position by hand to avoid damaging the bolt and nutsert threads.

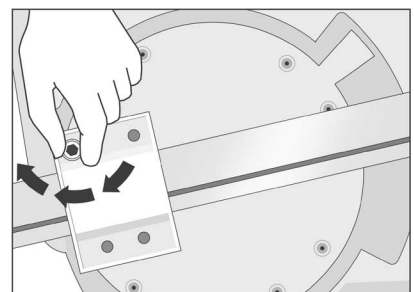

- 5 When all the bolts are installed and finger-tight, tighten them further with the Allen key.

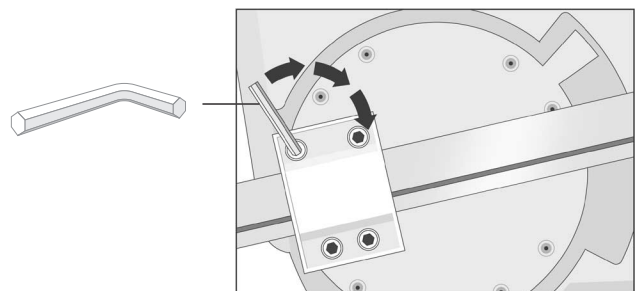

**1** On the selected accessible side of the bed, slide the stabiliser between the mattress and bed-base about 600mm from the bedhead, bracket upwards, with the stabiliser nut facing out. For frame beds with a rim to contain the mattress, use the adjustment bolts to align the brackets flush with the edge of the bedframe. Bring both cords under the mattress to the far side of the bed.

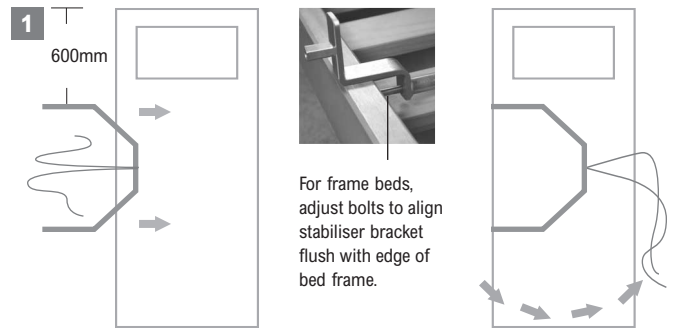

**2** On the far side of the bed, clip one end of the cord to the ring on the back-fixing. Thread the other end of the cord through the hole in the black plastic cleat.

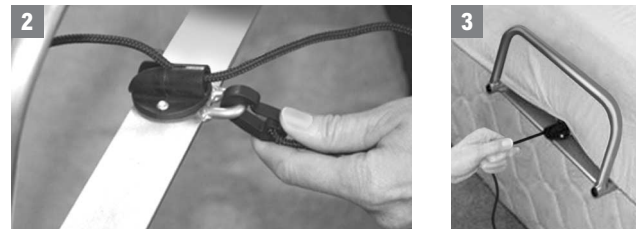

**3** Insert the back-fixing between mattress and bed-base, centred opposite the stabiliser bar. Pull on the cord until it is taut.

**4** Place the LegLifter at the accessible side of the bed, with the handgrip towards the bedhead. Align the vertical slot nearest the bedhead over the corresponding stabiliser nut. Screw the fixing bolt, washer and plate into position by hand.



**5** Turn the adjustable foot until the pivot point is about 75mm below the top of the mattress. Lift the lower end of the unit onto the corresponding stabiliser nut.

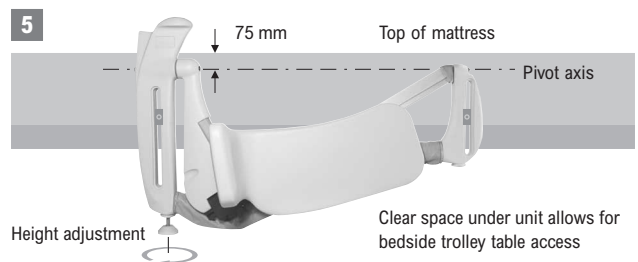

**6** Screw the fixing bolt, washer and plate into position by hand. Lift the lower end of the unit and align the pivot points so that they are level (parallel to the top of the mattress). Tighten the bolt with the Allen key until the plate fits snugly into its recess and the lower end is firmly supported.



**7** Tighten the bolt nearest the bed-head with the Allen key until the plate fits firmly into its recess.

**8** On the far side of the bed, pull the cord taut and then upward to lock the cord in the black plastic cleat of the back-fixing. Tuck any remaining cord out of sight under the mattress.

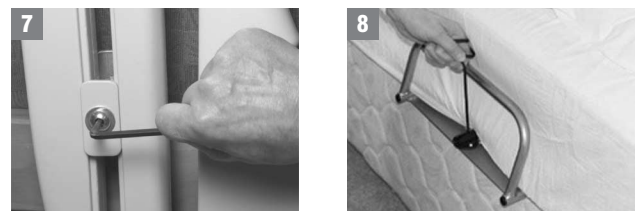

**9** Connect the handset to the control box, ensuring that the keyways of the plug and socket are properly aligned as you insert the plug. Ensure that the connection is secure. Hang the handset on the bracket near the handgrip. Connect the mains-power lead to a power outlet. Ensure that the connection is secure. Position the control box and power lead safely out of traffic areas where they could cause a trip-hazard.

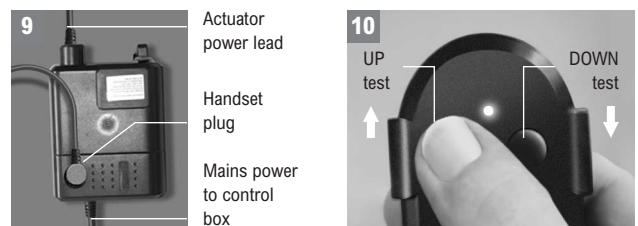

**10** Turn the power on at the power outlet. Activate the UP and DOWN buttons on the handset to check for smooth operation.

## 6 How to use the Multifit LegLifter

### Getting into bed

**1** Sit on the bedside with the buttocks as far into the bed as possible with the legs draped directly over the leg-rest. Hold the LegLifter handgrip with one hand to assist balance.

**2** Holding the handset with the free hand, press the UP button to start the lifting action. The green handset light will turn ON to indicate that the leg-rest is in motion.

**3** Keep the free hand on the handgrip. Recline onto the elbow nearest the bed-head as the legs begin to rise, with the intention of resting the head on the centre of the pillow.

The lifting action will deliver the legs towards the centre of the mattress and stop automatically. The handset light turns off when the leg-rest has finished its upward motion.

**4** Press the DOWN button on the handset. The handset light turns on to indicate the downward motion. The leg-rest will withdraw from under the legs. The legs may then be adjusted to a more comfortable position if necessary.

**5** The leg-rest stops automatically on reaching its original bedside position. The handset light turns off.

### Getting out of bed

■ Before getting out of bed, ensure that the leg-rest is fully lowered (to check, handset light will be off when the DOWN button is pressed).

■ Use the handgrip to assist sitting in bed.

■ Move the legs over the bedside and let gravity take the feet to the floor.

**Note: The Multifit LegLifter is not designed or recommended to carry the legs out of bed!**



To perform the task of getting out of bed with the LegLifter, the upper body would have to be raised to a sitting position at the same speed as the legs are being lowered. This may cause difficulty, distress or injury to a disabled person. We recommend the above method for getting out of bed.

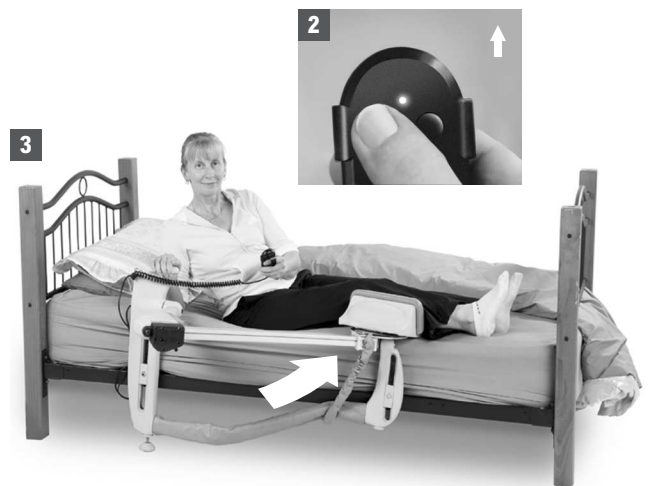

### Cleaning

- Disconnect from the power source before cleaning. Do not allow any moisture to get into electrical parts.
- Using a household or hospital-grade detergent solution, wipe with a damp cloth. Dry thoroughly.
- To disinfect, wipe all surfaces thoroughly with either alcohol-impregnated wipes, mild disinfectant solution or spray, and allow to dry.
- Regularly clean your Multifit LegLifter, particularly around the pivot point (at the lower end of the appliance), the underside of the leg-rest and handgrip.
- Never use water-blasting as a cleaning method for this appliance!
- Store the appliance in a clean, dry place.

### Regular maintenance check

Your Multifit LegLifter is designed and manufactured to the highest quality standards for materials and craftsmanship to minimise maintenance and to ensure many years of satisfactory service. However, a regular check for signs of wear will ensure a longer working life for your appliance. Check for signs of possible wear to the following:

Date (month/year)	<input type="text"/>	<input type="text"/>	<input type="text"/>
1 underside of the leg-rest	<input type="checkbox"/>	<input type="checkbox"/>	<input type="checkbox"/>
2 pivot bushes	<input type="checkbox"/>	<input type="checkbox"/>	<input type="checkbox"/>
3 actuator rod thread	<input type="checkbox"/>	<input type="checkbox"/>	<input type="checkbox"/>
4 actuator carriage nut	<input type="checkbox"/>	<input type="checkbox"/>	<input type="checkbox"/>
5 actuator rod end bearings	<input type="checkbox"/>	<input type="checkbox"/>	<input type="checkbox"/>

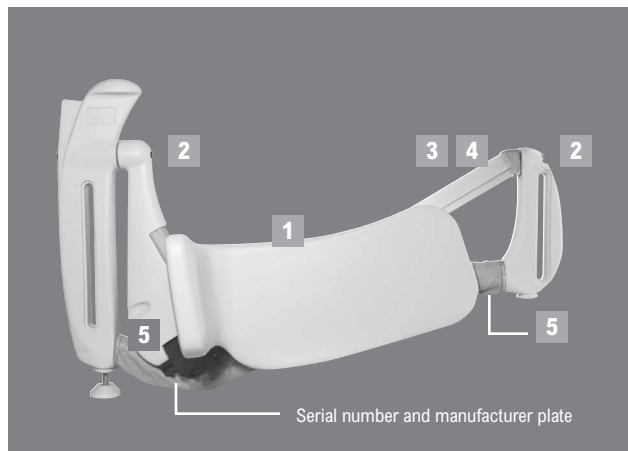

Multifit recommends that the LegLifter be inspected every year by your supplier or other suitably authorised person.

### Storage

- Clean the Multifit LegLifter and ensure that it is completely dry before storing.
- Wrap a dust-cover around the appliance or return it to its original packing box for protection.
- Store the entire Multifit LegLifter system components together in a clean, dry place.

### Trouble-shooting guide

If the appliance does not operate on command, check the following, and test individually after each action:

- Ensure that mains power cable is connected and switched on.
- Ensure that the keyways on all plugs and sockets are aligned correctly, and that all plugs are connected firmly to the control box.
- If the appliance has been used excessively, the overload switch in the control box will activate. Allow the unit to cool. The overload switch will reset when the unit has returned to a normal working temperature.
- If your handset has an active key-lock, check that the key is inserted correctly. The handset is immobilised if the key is removed.
- The safety bar, which turns the motor off on sensing an obstruction behind the leg-rest, may have been activated. Ensure that there is no hindrance (including blankets) to full downward movement of the leg-rest to the bedside. Ensure that both upward and downward trajectories of the leg-rest have clear passage.



### End-of-life disposal of appliances

The appliance's electrical and electronic components cannot be discarded through general waste disposal. Return the complete unit to your supplier, where it may be renovated for further use or recycled at an authorised facility. The Multifit LegLifter control box conforms to the requirements of EMC directive 2004/108/EC and Low Voltage Directive 2006/95/EC. The actuator and handset are considered benign for electromagnetic immunity and emissions.

## Specifications

<b>Total weight of system</b>	16 kg
<b>Weight of LegLifter unit</b>	9 kg
<b>Width of unit without leg-rest</b>	60 mm
<b>Overall length of unit</b>	1050 mm
<b>Installation time</b>	10 minutes

<b>Adjustment range of unit</b>	300 - 700 mm
---------------------------------	--------------

<b>Width of leg-rest</b>	Standard	285 mm
	Wide	485 mm

<b>Maximum user load (legs only):</b>	67 kg
---------------------------------------	-------

Determined by width of user's legs (across both calves) and the leg-rest model to suit. Overall width of user's calves must not exceed above widths for selected leg-rest. Tested to carry 67 kg load without failure (safety factor over 4x)

<b>Power supply from control box</b>	28V
--------------------------------------	-----

TiMotion TC2B control: standard  
TiMotion TC1 control: optional  
Refer page 3 for details.

*Note: Do not use any control box other than the model supplied with the appliance.*

<b>Operating temperature range</b>	10°C - 40°C
------------------------------------	-------------

<b>Relative humidity range</b>	30% - 75%
--------------------------------	-----------

## Warranty

Multifit Hospital Supplies Ltd guarantees the Multifit LegLifter system for a period of two years against defects in materials and workmanship. This excludes fair wear-and-tear, wilful damage, common neglect, misuse, accidental damage, unauthorised alteration or repair by unauthorised persons or use of a power supply control box other than that supplied with the appliance. In the event of defects in manufacture or materials occurring within the warranty period, Multifit will rectify the fault, free of charge, on provision of the original purchase invoice, dated no more than two years prior to date of claim.

## EC Declaration of Conformity



### CEproof International Ltd

Hilliard House, Lester Way, Wallingford, Oxfordshire OX10 9TA, United Kingdom

<b>Description of product</b>	Multifit LegLifter
<b>Model</b>	Mk3 and Mk3L Serial Nos: 00004-10000
<b>Name of manufacturer</b>	Multifit Hospital Supplies Ltd
<b>Address</b>	10 Pohutu St. Whakatane, New Zealand
	PO Box 748 Whakatane 3120, New Zealand

We hereby declare that the product described above complies with the relevant provisions of the appropriate *EC Directives, Harmonised Standards of the European Union* and other recognised standards listed below and accordingly carries CE marking:

**Medical Devices Directive** 93/42/EEC

**Electromagnetic Compatibility Directive** 2004/108/EC

**Low Voltage Directive** 2006/95/EC

The following standards are applicable:

EN 55014-1: 2006	EN 61000-3-2: 2006
EN 55014-2: 1997 + A1: 2001	EN 61000-3-3: 1995 + A1: 2001 + A2: 2005
EN 55022: 1998 + A2: 2003	EN 61558-1: 2005
EN 55024: 1998 + A2	EN 61558-2-6: 1997

Date of Declaration: 12/11/2009 Date of Issue: 12/11/2009

Wayne Manson: *Managing Director, Multifit Hospital Supplies Ltd*

CEproof International Ltd: *Keeper of Technical Documents in the European Union*



# Multifit

Multifit Hospital Supplies Ltd  
PO Box 748 Whakatane 3120 New Zealand  
Tel +64 7 308 0045  
www.multifit.co.nz export@multifit.co.nz

© 2010 Multifit Hospital Supplies Ltd. The Multifit LegLifter appliance is a patented device. Multifit and LegLifter are trademarks of Multifit Hospital Supplies Ltd. Published June 2010

## Your Multifit LegLifter distributor: